

CX 12

Point Source Speaker

Part number CX 12 L: 1007626

Part number CX 12 R: 1007627

The CX 12 is a powerful and flexible multi-functional loudspeaker with a very high efficiency and deep frequency range. It can be used anywhere where a high sound pressure level paired with high speech intelligibility is required.

Exceptional phase linearity, a wide dynamic range and a BEM-optimised high-frequency horn ensure a very precise dispersion pattern. The multi-functional housing makes the CX 12 ideal for demanding stage monitoring applications.

Characteristics

- Compact, passive 12"/1.4" full-range speaker
- Multi-functional cabinet
- Transparent resolution and very precise dispersion pattern thanks to Boundary Element Method-optimised high-frequency horn
- 4x NL4 speakon connectors
- Cabinet made of birch multiplex with resistant PU coating
- HK Audio DuoTilt Adapter
- Expandable with C SUB subwoofer models
- Ideal as an FOH and delay speaker as well as a stage monitor or front-fill

Applications

- Stage monitor
- Nearfill
- Sidefill
- FOH top
- Near-field sound reinforcement with high SPL requirements



Technical data

CX 12 L/R	
Power-handling nominal (RMS)	500 W
Power-handling, program	1000 W
Frequency response +/-3 dB	70 Hz - 18 kHz
Frequency response -10 dB	61 Hz - 19 kHz
Sensitivity 1 W @ 1 m	99 dB (100 Hz - 10 kHz), full space
Max. SPL @ 10% THD (EN 60268-21:2019)	131 dB
Electrical impedance	8 ohms
Low/mid speaker	1x 12", 3" voice coil
HF Driver	1.4", 3" voice coil
Directivity	75° x 55°, rotatable CD horn
Crossover frequency	1.2 kHz, 24 dB/oct.
Connections	4x Speakon NL4 (with sealing cap), pin assignment switch
Angles up	35°/55° (monitor / frontfill)
Pole mount	DuoTilt 3°/7°
Rigging points	10x M10, 1x Aeroquip
Carrying handles	3x recessed grip
Housing	Birch multiplex
Finish	PU coating black
Front grille	Steel front grill with anticorrosive coating, acoustic foam
Dimensions (WxHxD)	37,5 x 67 x 33 cm 14-49/64 x 26-3/8"
Weight	22.8 kg / 50.2 lbs

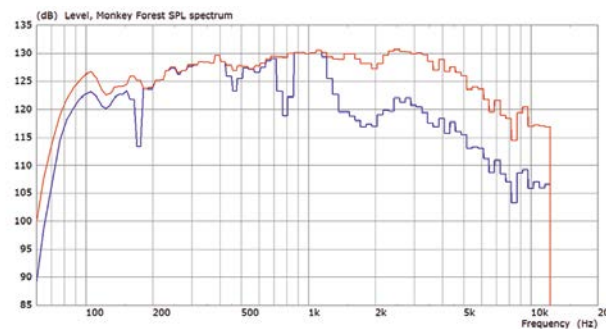

Max. SPL
(blue = 3 % THD, red = 10 % THD)

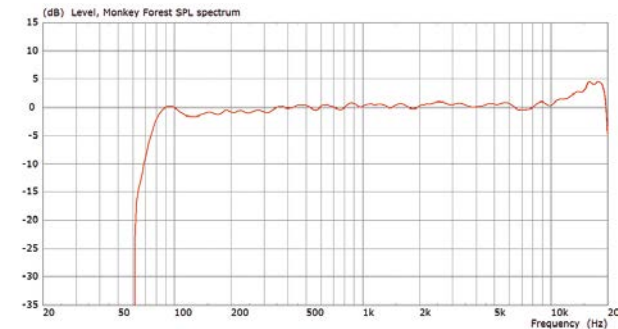

Frequency response (with controller)

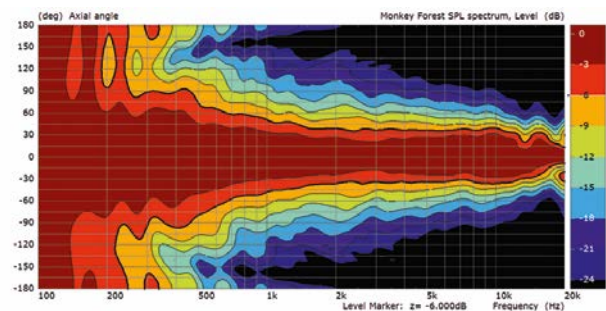

Horizontal directivity

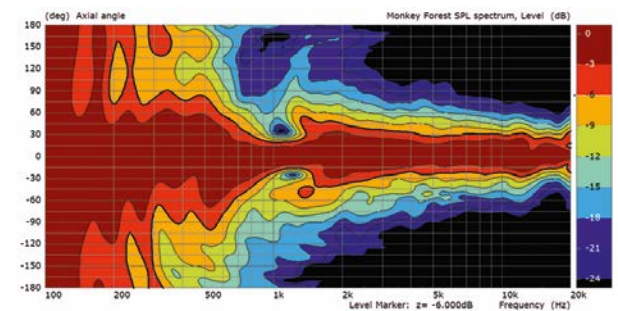

Vertical directivity

Accessories

TB-XNQ

Part number: 1007781

Universal tilt bracket for mounting the CX 12 on truss rods, ceilings, wall brackets, beams and on tripods.



AP-10B

Part number: 1007664

Optional attachment points for CX, for safe installation of the speakers on steel cables or chains.



Cover CX 12

Part number: 1007709

Padded, lockable transport protection cover for road-proof transportation of the CX 12.



Case 2CX12

Part number: 1007686

Optional flight cases in black for 2x CX 12.



Case 4CX12

Part number: 1007688

Optional flight cases in black for 4x CX 12.



CX 12 Point Source Speaker



PROFESSIONAL

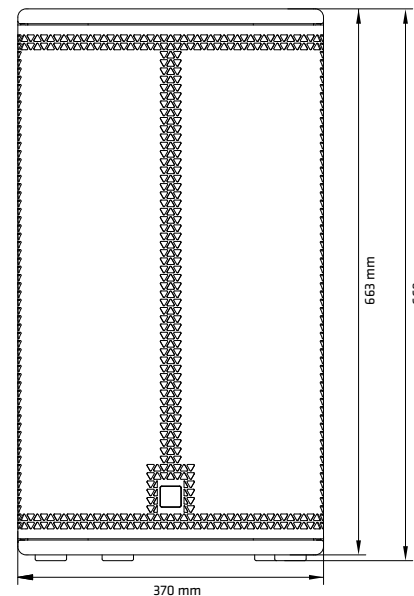
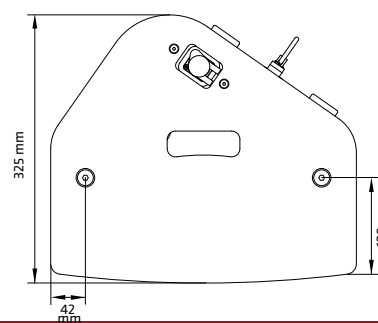
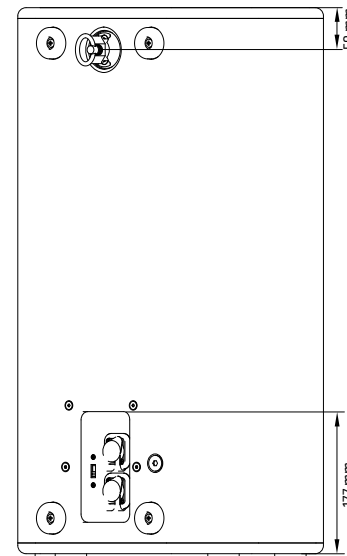
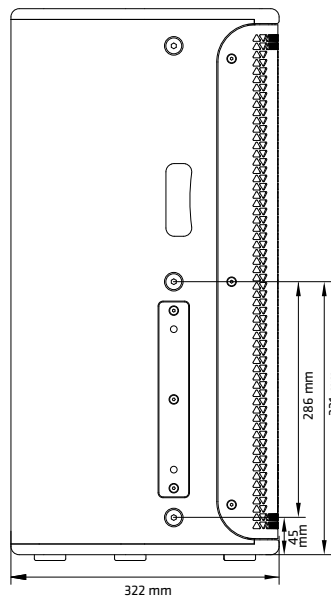

HK Audio
Postfach 1509
66595 St. Wendel, Germany

info@hkaudio.com
fax +49-68 51-905 215
www.pro.hkaudio.com

Simulation and CAD files, tender specifications, certificates and much more can be found at www.pro.hkaudio.com

Subject to change without notice
Copyrights 2020 Music & Sales GmbH
05/2020